

Pinces tirées - Zugspannzangen - Pull-type collets

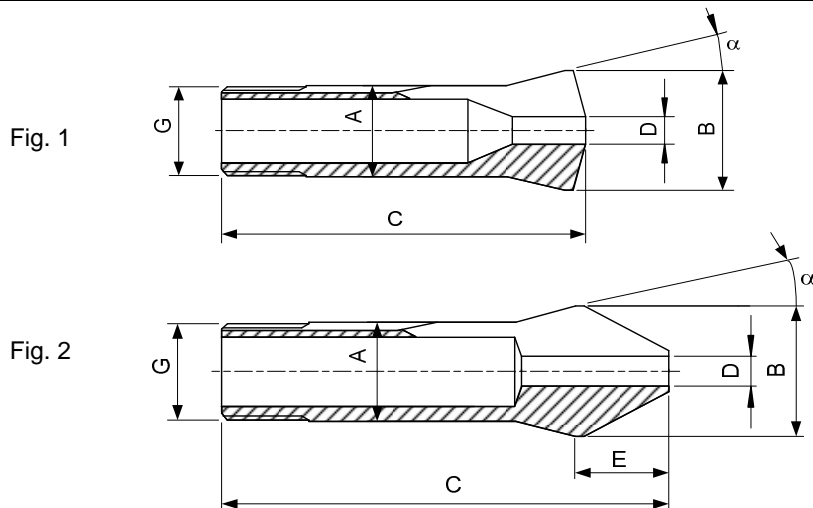

Alésage à cran
 Stufenbohrung
 Step bore



Obturateurs pour pinces, voir page 70
 Dichtgummi für Spannzangen auf Seite 70
 Rubber seals for collets on page 70

Type	Art.	A	B	C	E	G	α	D min-max		L	Fig.
W10	80-1	10	14	43.6	-	$\emptyset 9.83 \times 0.833$	$\sphericalangle 45^\circ/5^\circ$	15°	0.30...6.70	-	1
									6.71...8.00	15	
									8.01...8.50	6	
									8.51...9.00	5	
									9.01...9.50	4	
									9.51...10.00	3	
W10	80-2009	10	14	49.5	8	$\emptyset 9.83 \times 0.833$	$\sphericalangle 45^\circ/5^\circ$	15°	0.30...6.35	-	2
									6.36...8.00	21	
W12	80-2	12	16	46	-	$\emptyset 11.75 \times 1.25$	$\sphericalangle 45^\circ/5^\circ$	15°	0.30...8.00	-	1
									8.01...10.00	17	
									10.01...10.50	6	
									10.51...11.00	5	
									11.01...11.50	4	
									11.51...12.00	3	
								12.01...12.50	2		
W12	80-93108 10) 80-2	12	16	52	8.8	$\emptyset 11.75 \times 1.25$	$\sphericalangle 45^\circ/5^\circ$	15°	0.30...8.00	-	2
									8.01...10.00	24	
W15	80-3	15	20.2	58.3	-	$\emptyset 14.75 \times 1.25$	$\sphericalangle 45^\circ/5^\circ$	15°	0.30...10.70	-	1
									10.71...12.70	22	
									12.71...13.00	9.5	
									13.01...13.50	8.5	
									13.51...14.00	7.5	
									14.01...14.50	6.5	
									14.51...15.00	5.5	
15.01...15.50	4.5										
								15.51...16.00	3.5		
W15	80-93285 10) 80-3	15	20.2	67	12	$\emptyset 14.75 \times 1.25$	$\sphericalangle 45^\circ/5^\circ$	15°	0.30...10.20	-	2
									10.21...12.70	32	

Alésages standards (rond, carré, six-pans) selon liste de prix. Autres alésages sur demande.
 Standardbohrungen (rund, vierkant, sechskant) gemäss Preisliste. Andere Bohrungen auf Anfrage.
 Standard bores (round, square, hexagonal) according to price list. Other bores on request.

10) Article de base - Basisartikel - Basic item