

Pinces poussées - Druckspannzangen - Dead length collets

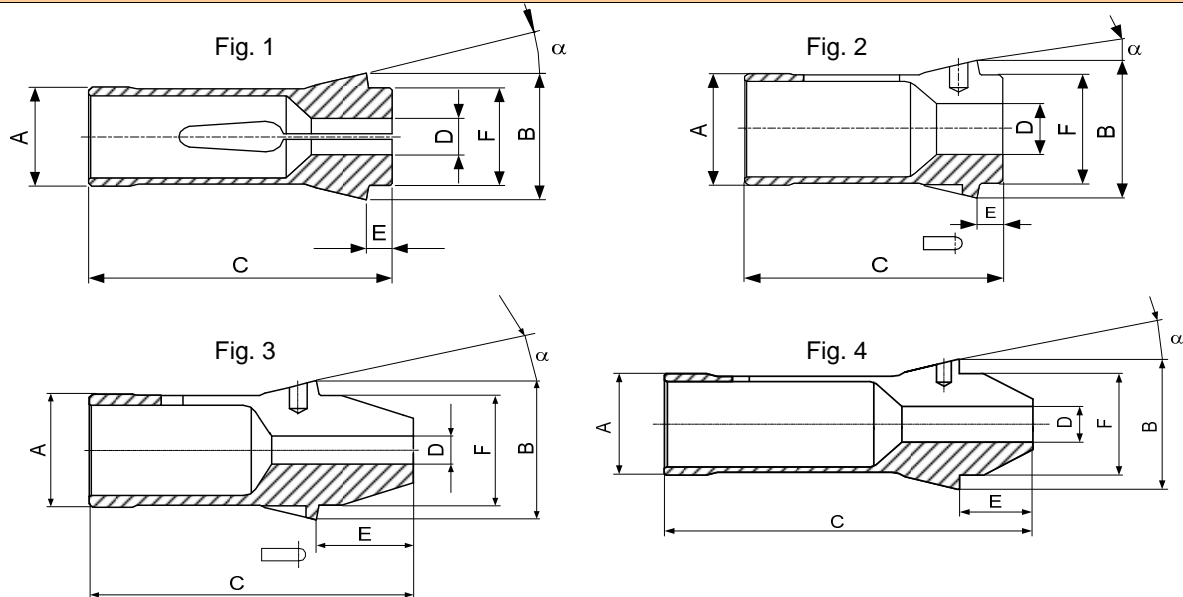

Type	Art.	A	B	C	E	F	G	α	D min-max			Fig.
									○	□	⬡	
F35	76-94	35	48	80	8	38	-	15°	1.0-30.0	2.0-21.0	2.0-26.0	1
	76-2010 22) & 29)	35	43	70	7	34	-	15°	14.0-30.0			2
	76-2013 10) 76-2010	35	43	90	27	34	-	15°	2.00-27.7			3
F37	76-740	37	47	92	10	40	-	16°	1.0-32.0	2.0-22.6	2.0-27.7	1
	76-2020 10) 76-740	37	47	107	25	40	-	16°	1.0-32.0	2.0-22.6	2.0-27.7	4
F38	76-72	38.08	49	107.5	9	38	-	15°	1.0-32.0	2.0-22.0	2.0-27.0	1
	76-2004 10) 76-72	38.08	49	123	24.5	38	-	15°	1.0-32.0	2.0-22.6	2.0-27.7	4
F42	76-99	42	55	94	9	42	-	15°	1.0-36.0	2.0-25.0	2.0-31.0	1
	76-2006 10) 76-81	42	55	94	9	42	-	15°	1.0-36.0	2.0-25.0	2.0-31.0	4
F48	76-81	48	60	94	9	50	-	15°	1.0-42.0	2.0-30.0	2.0-36.0	1
	76-2006 10) 76-81	48	60	113	28	50	-	15°	2.0-42.0	2.0-29.5	2.0-36.0	4
	76-2007 10) 76-81	48	60	94	9	50	-	15°	1.0-42.0	2.0-30.0	2.0-36.0	2
	76-2026 10) 76-81	48	60	113	28	50	-	15°	2.0-42.0	2.0-29.5	2.0-36.0	3
F66	76-359	66	84	110	9	73	-	15°	3.97-60.0	3.97-42.0	3.97-52.0	1

Alésages standards (rond, carré, six-pans) selon liste de prix. Autres alésages sur demande.
 Standardbohrungen (rund, vierkant, sechskant) gemäss Preisliste. Andere Bohrungen auf Anfrage.
 Standard bores (round, square, hexagonal) according to price list. Other bores on request.

- 10) Article de base - Basisartikel - Basic item
- 22) Pour alésages en dessous de 14 mm - Für Bohrungen kleiner als 14 mm, voir - siehe 76-2013 - For bores under 14 mm, see part number 76-2013
- 29) Article de remplacement pour 76-67- Ersatzartikel für 76-67 - Replacement article for 76-67